



ASSEMBLY INSTRUCTIONS

SY-WCSL-30-IM

COMPONENT LIST

NO	Description	Q'TY
1	①	1 PC
2	②	2 PCS
3	③	2 PCS
4	④	1 PC
5	⑤	2 PCS
6	⑥	1 PC
7	⑦	1 PC
8	⑧	1 PC
9	⑨	2 PCS
10	⑩	2 PCS
11	⑪	1 PC

HARDWARE PACK

NO	Drawing	Description	Q'TY
A		Screw (#8*25mm)	46PCS
B		Screw (#10*80mm)	3PCS

STEP 1

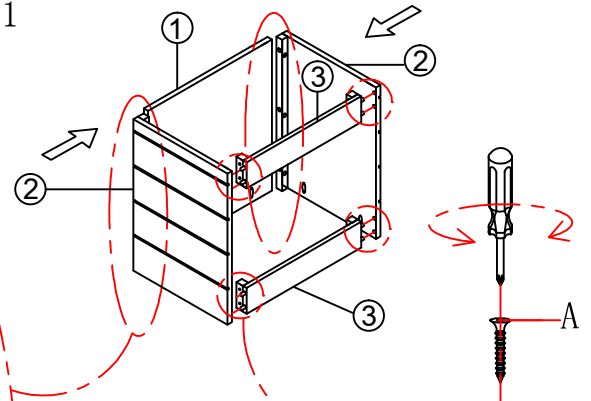

STEP 2

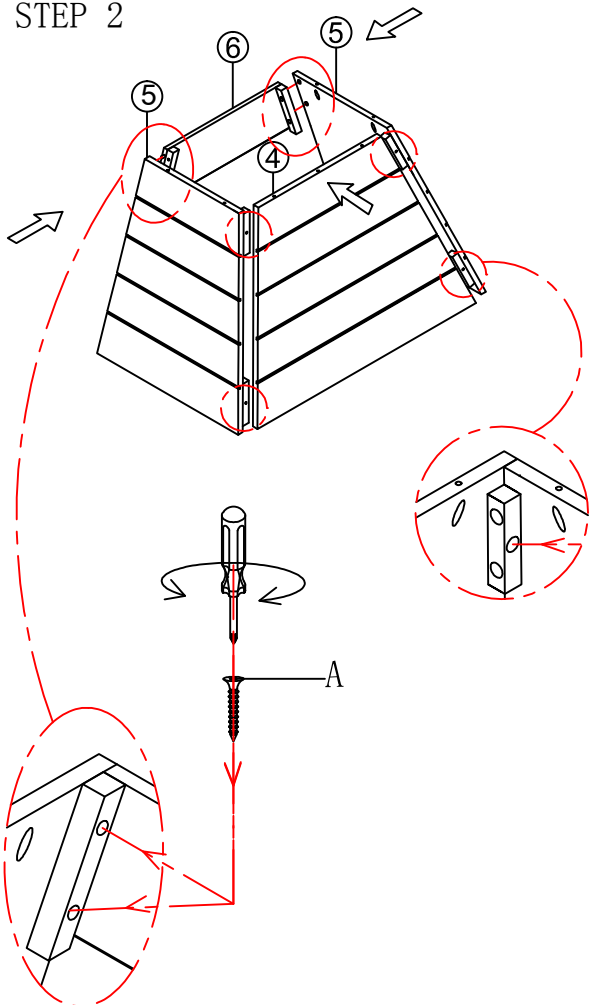

STEP 3

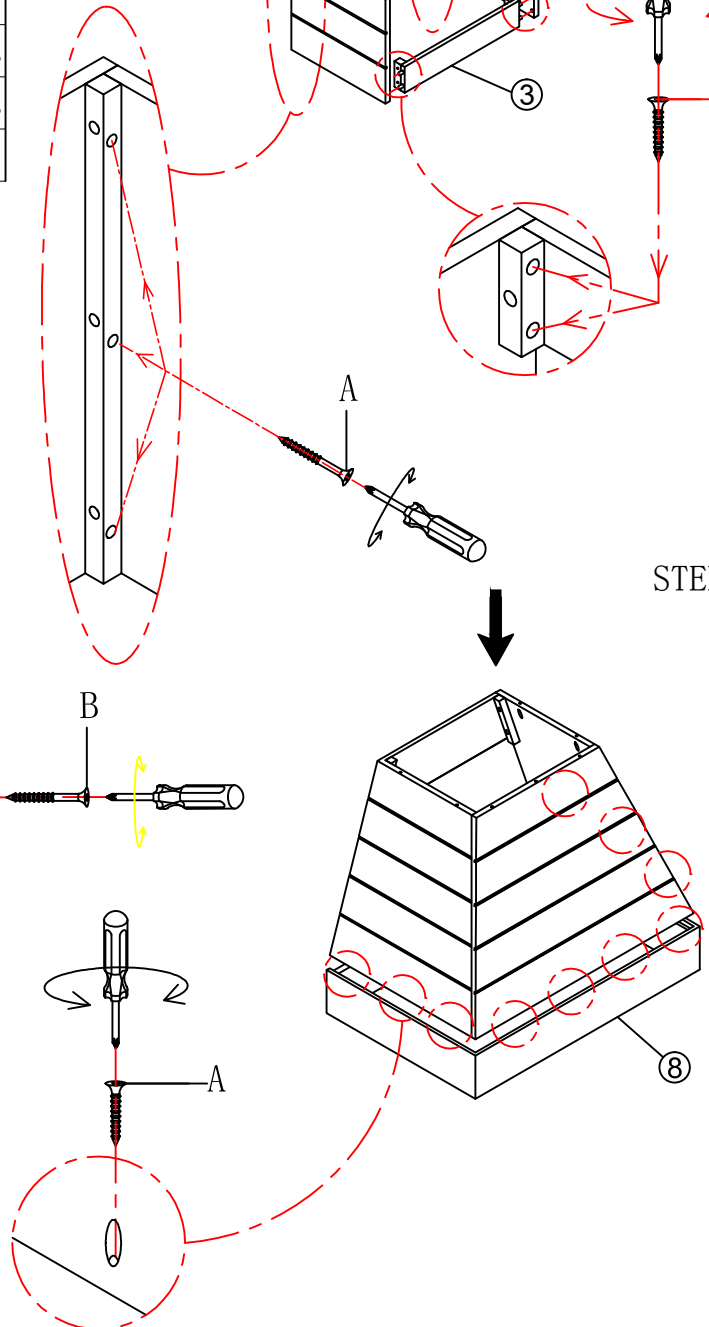

ASSEMBLY INSTRUCTIONS

STEP 4

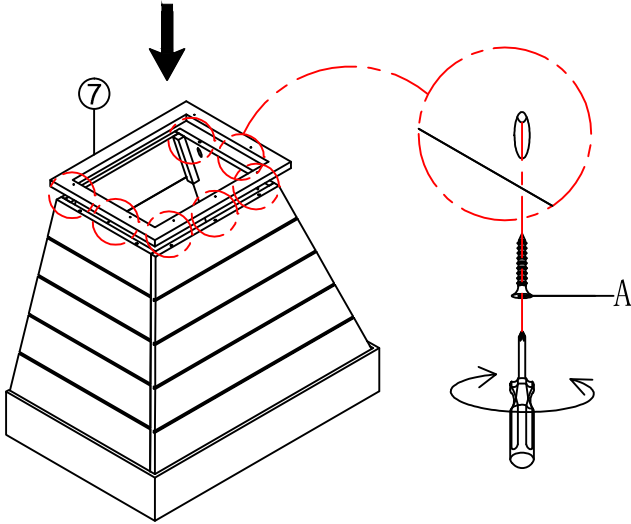

STEP 5

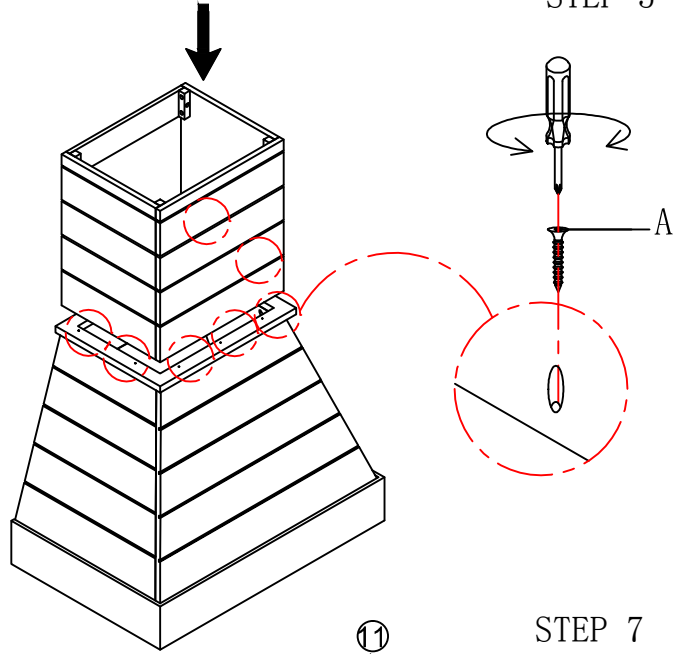

STEP 6

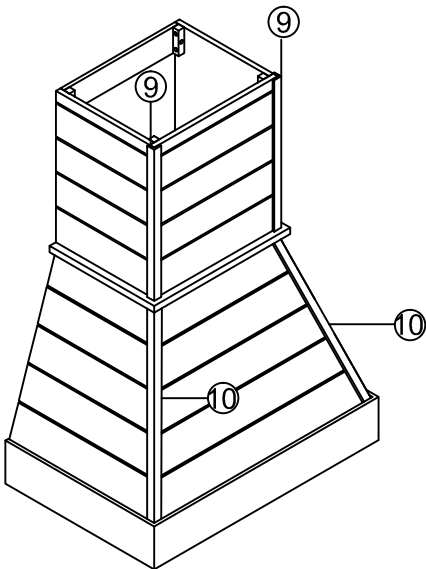

STEP 7

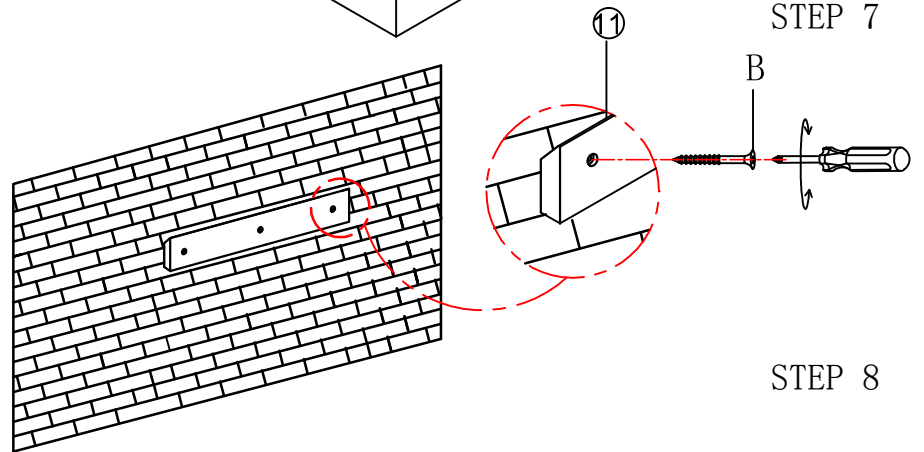

STEP 8

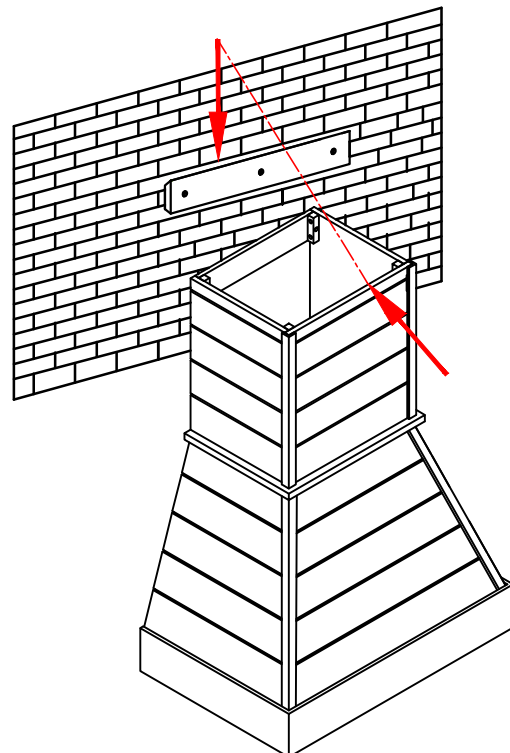

STEP 9

